

Table Of Contents

13	Operating and installation instructions	1
14	General for instructions	1
14.1	Standards and Directives	1
14.2	Intended use	2
14.3	Foreseeable misuse	2
14.4	Warranty and liability	2
14.5	Customer service of the manufacturer	2
15	Safety	2
15.1	General safety instructions	2
15.2	Layout of the safety guidelines	2
16	Product description	3
17	Assembly	3
17.1	Mechanical fastening	3
17.2	Electrical connection	4
17.3	Connection example, RoTop 230 V/50 Hz	4
17.4	Parallel connection	4
17.5	Commissioning	4
17.6	Setting the end positions and the relief	5
17.6.1	Relief function for the end position(s)	5
17.6.2	Relief function at the upper stop	5
17.6.3	Relief function at the lower stop	5
17.6.4	Changing / Deleting the limit positions and deleting the discharge function	5
17.6.5	Four variants of end position settings	5
17.6.6	Variant A: Upper and lower end position freely adjustable	5
17.6.7	Variant B: Fixed upper limit stop / lower end position freely adjustable	6
17.6.8	Variant C: Fixed upper and lower limit stop	6
17.6.9	Variant D: Upper end position freely adjustable, fixed lower limit stop	6
18	Troubleshooting	6
19	Repair	7
20	Repair	7
21	Manufacturer's address	7
22	Disassembly and disposal	7
23	Conformity Declaration	7

24	Technical data and dimensions	7
24.1	RevoLine S	8
24.2	RevoLine M	9
24.3	RevoLine s_onro M	10
24.4	RevoLine L	11

RoTop Roller Blind Drive

13 Operating and installation instructions

Please keep these operating instructions for later use, to be available throughout the life of the product!

The German manual is the original version.

All other documents represent the language translations of the original text.

All rights in the case of a patent, utility model or ornamental design registration are reserved.

14 General for instructions

The content structure is based on the life cycles of the electric motor drive (hereinafter referred to as "Product").

The manufacturer reserves the right to make changes to the Specifications stated in these Operating Instructions at any time. These may, in individual cases, be different from the respective product version, however the functional information will not undergo significant changes or become invalid. The current version of the Specifications may be requested from the manufacturer at any time. No claims may be asserted against the manufacturer as a result of the preceding sentence. Deviations from text or picture statements are possible and depend on the technical development, features, and accessories of the products. Deviating information on special versions will be explained by the manufacturer in the sales documentation. Other information shall remain unaffected by these provisions.

14.1 Standards and Directives

During the design process, the basic health and safety requirements of the applicable laws, Standards and Directives were complied with. The safety is confirmed by the declaration of conformity (see "Declaration of Conformity"). All safety information in these Operating Instructions refer to the laws and regulations currently applicable in Germany. All instructions in the Operating Instructions shall be observed without limitation and at any time. Beside the safety instructions contained in these Operating Instructions, the provisions for accident prevention, environmental protection and occupational safety, which are applicable for the operating site, must be observed. Provisions and Standards for the safety rating can be found in the Declaration of Conformity

14.2 Intended use

The product is intended for use in façade engineering to drive electrically powered sun protection devices.

The determining factor for the drive is the elero drive computation program

www.elero.com/drive-calculation/

Further fields of application have to be arranged with the manufacturer, **elero** GmbH Antriebstechnik (see Address).

The operator will be solely responsible for damages resulting from improper use of the product. The manufacturer cannot be held liable for personal or material damages caused by misuse or procedural errors, and by improper operation and commissioning.

The product may be operated only by trained and authorized personnel under observance of all safety.

Only if used according to the specifications of these operating and installation instructions for the safe and proper use and safe operation of the product are guaranteed.

Intended use includes the observance and compliance with all safety instructions with regards to this operating manual and all applicable regulations, and professional associations of applicable laws for environmental protection. Intended use includes the observance of prescribed operating rules in these operating and installation instructions.

14.3 Foreseeable misuse

A use which deviates from the intended use stated by the manufacturer, **elero** GmbH Antriebstechnik (see "Address"), is deemed as foreseeable misuse.

14.4 Warranty and liability

Principally, the General Terms and Conditions of the manufacturer, **elero** GmbH Antriebstechnik (see "Address"), apply. The terms and conditions are part of the sales documents and handed over to the operator upon delivery. Liability claims for personal or material damages are excluded when they can be attributed to one or more of the following causes:

- Opening of the product by the customer
- Unintended use of the product
- Improper installation, commissioning, or operation of the product
- Structural modifications to the product without the written consent of the manufacturer
- Operation of the product with improperly installed connections, defective safety devices or improperly installed safeguards
- Non-observance of the safety provisions and instructions of these Operating Instructions
- Non-compliance with the technical data

14.5 Customer service of the manufacturer

The product should only be repaired by the manufacturer in case of a failure. The address for sending to customer service, see the chapter "Address".

If you have not purchased the product directly from elero, please contact the supplier of the product.

15 Safety

15.1 General safety instructions

The general safety notes when using pipe drives can be found in the leaflet "Instructions on safety" that is enclosed with each drive"(leaflet item no. 138200001). These operating instructions contain all the safety instructions that must be observed in order prevent and eliminate hazards in the handling of the product in the individual life cycles. The safe operation of the product can only be ensured when all given safety instructions are observed.

15.2 Layout of the safety guidelines

The safety instructions in this document are identified by hazard signs and safety symbols and are designed according to the SAFE principle. They contain information on the nature and source of the danger of possible consequences and to prevent the danger.

The following table defines the representation and description of hazard levels with possible personal injury, as used in this manual.



Symbol	Signal word	Meaning
	DANGER	Warns before an accident, which will result if instructions are not followed, which can lead to life-threatening, irreversible injury or death.
	WARNING	Warns before an accident, which can happen if the instructions are not followed, which can lead to serious, possibly fatal, irreversible injury or death.
	CAUTION	Warns before an accident, which can happen if the instructions are not followed, which may lead to minor reversible injury.

Fig. 1 Notation of personal injury

The following table describes the icons used in these operating instructions that are used for imaging of the dangerous situation in connection with the symbol of the threat level.

Symbol	Meaning
	Danger of electric voltage, electric shock: This symbol indicates a risk of electric shock.

Fig. 2 Notation-specific hazard

The following table defines the representation used in the operating instructions and description of situations where damage can occur to the product or refers to important facts, conditions, tips and information.



Symbol	Signal word	Meaning
	NOTE	This symbol warns of a possible property damage.
	Important:	This symbol points out important facts and conditions as well as to additional information in these operating and installation instructions. It also refers to certain statements that give additional information or help you perform a task easily.

Fig. 3 Notation of property damage as well as additional information

The following example represents the basic structure of a safety warning:

SIGNAL WORD

Type and source of danger
 Explanation of the type and source of the danger
 ► Measures to prevent the danger.

16 Product description

The RoTop is an electromechanical tubular motor drive. It performs parallel axial movements.

- Commissioning of the RoTop with **elero** assembly cable for setting different functions.
- Venetian blind with free ride (torque deactivation)
- Relief function for the Venetian blind (Venetian blind protection).
- Type s_onro with soft stop downwards
- The variant-dependent values of your RoTop can be removed from the type label.
- The different versions of the RoTop contain different types of brake systems depending on size and torque. The result may yield different performance e.g. regarding access to end positions.

17 Assembly

 **CAUTION**

Personal injury from hot surfaces.
 Drive heats up during operation, the drive housing can be hot. Possible burning of the skin.
 ► Wear personal protective equipment (gloves).

Triggered by a possible material errors may occur or impact shock and injury due to a gearbox break, bud break or a clutch defect.
 ► Suitable materials are to be used for the construction as well as perform a sampling inspection by double load test according to DIN EN 60335-2-97.

Risk of injury due to impact or shock caused by not properly mounted or latched motor bearings. Hazards caused by insufficient stability or stability and stored energy (gravity).
 ► Selection of engine bearing torque specifications.
 ► Drive must be backed up with all attached backup devices.

- Check for proper latching on engine mounts and correct tightening torques.

 **WARNING**

Danger of injury due to electric current.



Electric shock possible.

- Electrical work can only be performed by an authorized electrician.

Danger of injury due to electric current.



Hazardous possibly by parts that have become live in the error state.

- Electrical connection is described in the operating and installation instructions including cable bushing.

 **CAUTION**

Risk of injury due to malfunctions due to improper installation.

Driven by winds and possibly destroyed parts of the application.

- For safe operation, the end positions must be set / programmed.
- Training program of the manufacturer for specialist companies.

NOTE



Loss of power supply, termination of machine parts and other malfunctions.

- For safe operation, no false mount must be made and the end position settings must be carried out during commissioning.



Damage to the RoTop due to moisture penetration.

- For devices with protection class IP44, the ends of all cables or connectors must be protected against the ingress of moisture. This measure must be implemented immediately after removal of the RoTop from the original packaging.
- The drive may only be installed so that it is not irrigated.

Important



In the delivery status (factory setting), the RoTop in commissioning mode.

- You have to set the end positions (see chapter 5.6).

17.1 Mechanical fastening

Important preliminary consideration:

The working space around the built-in drive is usually very small. Therefore, before the mechanical installation provide an overview of the implementation of the electrical connection (see Section 5.2) and make any necessary changes right away.

NOTE



Damage to the electrical wiring by squeezing or tensile loading.

- Route all electrical cables so that they are not subjected to crushing or tensile load.
- Note the bending radius of the cables (at least 50 mm).
- Lay the connection cable in a loop downwards to prevent water running into the drive.



Damage to the drive by the action of impact forces.

- Insert the drive into the shaft, never thrust the drive into the shaft or smash onto the drive!
- Never allow the drive to fall!

 Damage or destruction of the drive by drilling.
 ▶ Never drill into the drive!

Important

 Attach the RolTop only at the appropriate fasteners.
 Permanently installed control devices shall be clearly displayed.

- The curtain must be fastened to the winding shaft.
- The profile tube must have enough distance to the motor tube.
- Look for an axial clearance (1-2 mm).

Installation in profile tubes

Ⓐ Insert the drive with a suitable adapter and traction ring into the profile tube.
 Lay the motor cable protected in order to prevent damage by the driven component.

Ⓑ Secure the counter bearings against axial displacement, e.g. screw shaft spider or rivet.
 Secure drive in axial storage!

Ⓒ Secure hanging on the shaft!

Only operate the drive horizontally, as intended, with the connection cable loading out from the side and out of the blind winding area.

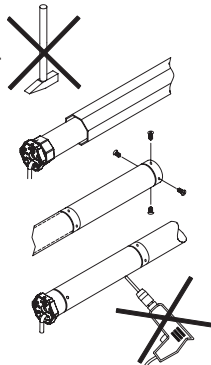



17.2 Electrical connection

 **WARNING**
 Danger to life due to faulty electrical connection.

 Electric shock possible.
 ▶ Before commissioning check the correct connection of the PE conductor.

NOTE

 Damage to the RolTop by faulty electrical connection.
 ▶ Before commissioning check the correct connection of the PE conductor.

 Damage or destruction of RolTop by the penetration of moisture.

▶ For units with protection class IP 44, the customer connection of the cable ends or connector (cable bushing) must also be carried out in accordance with protection class IP 44.

 Damage or destruction of RolTop for variants with 230 V AC 1 due to faulty control.

▶ Switch with OFF setting (Dead man) for drives must be installed within sight of the RolTop, but away from any moving parts and amounting to about 1.5 m.

Important

For electric connection no transmission and retransmission of the access line or connector is required as a rule.
 Depending upon used mounting plate and/or adapter plate it is necessary in particular with the RolTop Type S to remove this screwed plate before a cable exchange.

Connection only in free of tension status, in addition drive line without tension

- 1 Using a suitable screwdriver, press out the lock of the device connector to the line.
- 2 Disconnect the plug.
- 3 Insert connector until the latch engages.

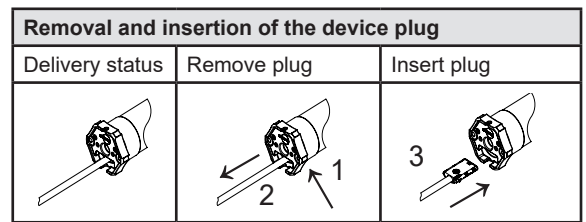

Fig. 4 Removal and insertion of the device plug

17.3 Connection example, RolTop 230 V/50 Hz

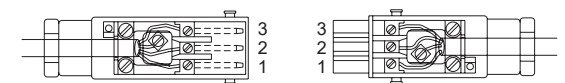
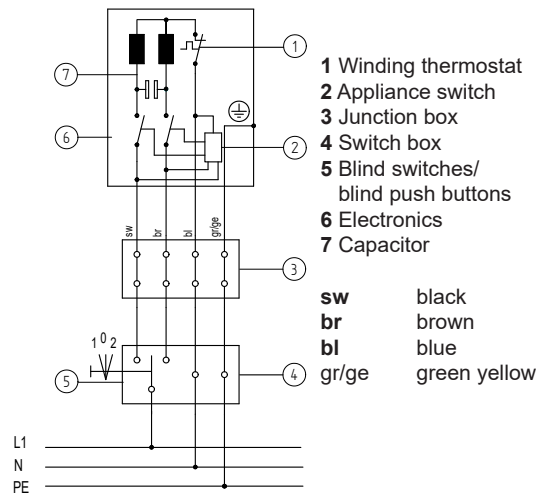



Fig. 5 Circuit diagram RolTop 230 V / 50 Hz and wiring when used with Hirschmann plug STAS 3

Important

 The motor control must be interlocked in up / down direction.

A reversing delay of at least 0,5 seconds must be ensured.

17.4 Parallel connection

Important

 You can connect several parallel RolTop. Note the maximum switching capacity of switching.

17.5 Commissioning

Important

 The drive is in the delivery in commissioning mode.
 ▶ You have to set the end positions with the **elero** assembly cable.
 ▶ Connection of the assembly cable is only admissible for commissioning of the drive and the setting processes.

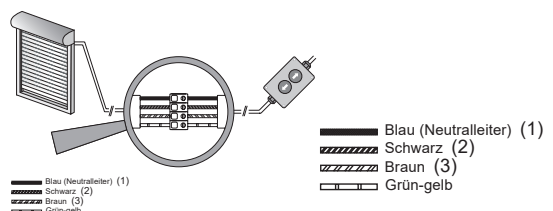

Fig. 6 Connection for cable assembly

- ▶ Switch on mains.
- ▶ You can now set the end positions with the **elero** assembly cable.

17.6 Setting the end positions and the relief

Important preliminary consideration:

Decide on a specific relief function before setting the end positions (different combination options according to the following statements):

This will save unnecessary setting effort!

Press the travel key until the drive signals the transition into the setting mode, by a short automatic stop. You can now program the end positions. After setting the two end positions, the setting mode is completed.

17.6.1 Relief function for the end position(s)

If an end position is set to stop, an additional relief for the Venetian blind can be released.

Important

i Activation of the relief function (in the versions B to D) takes place in one work step when the end positions are programmed (see chapter 5.6.7 to chapter 5.6.9)!

17.6.2 Relief function at the upper stop

For variant C (see chapter 5.6.7) and variant D (see chapter 5.6.8): Activate relief function at the upper stop.	
1	Push and hold the UP button ▲ from instruction ① (chapters 5.6.7 and 5.6.8) and actuate the DOWN button ▼ with the assembly cable (at the same time). Keep both buttons pushed until the Venetian blind stops.
The relief function at the upper stop is activated.	

17.6.3 Relief function at the lower stop

For version C (see chapter 5.6.8) and version D (see chapter 5.6.9): Activate relief function at the lower stop	
1	Push and hold the DOWNP button ▼ from instruction ③ (chapters 5.6.8 and 5.6.9) and actuate the UP button ▲ with the assembly cable (at the same time). Keep both buttons pushed until the Venetian blind stops.
The relief function at the lower stop is activated.	

17.6.4 Changing / Deleting the limit positions and deleting the discharge function

A change or deletion of a single end position is not possible. This is always done in pairs (upper and lower end position simultaneously).

By the deletion of the end positions and the adjustment of the optional discharge function is lost.

Important

i The Venetian blind is adjusted only after a complete and uninterrupted access and exit to the blind.

Changing / Deleting the end positions	
1	From a middle Venetian blind position with the assembly cable, push and hold both direction buttons (▲ and ▼) at the same time until the drive briefly moves up and down.
The deletion of the setting of end position is completed. The end positions can be programmed again.	

17.6.5 Four variants of end position settings

Four different combinations of end position settings are possible. They must be selected sensibly according to the technical requirements of the Venetian blind.

End position settings (4 versions)		possible with
A	Upper and lower end position freely adjustable	T-strap, tapes, belt
B	Fixed upper limit stop / lower end position freely adjustable	T-strap, tapes, belt, limit plugs, angle bracket
C	Fixed upper and lower limit stop	Anti push-up device, stiff shaft connector, limit plugs, angle bracket
D	Upper end position freely adjustable, fixed lower limit stop	Anti push-up device

Fig. 7 Versions of the end position settings in the RolTop

17.6.6 Variant A: Upper and lower end position freely adjustable

Variant A: Upper and lower end position freely adjustable	
①	From a middle Venetian blind position with the assembly cable, push the UP button ▲ until the Venetian blind has reached the desired end position. The drive starts, stops briefly and then moves on (while the UP button ▲ is pushed). Correction is possible with the buttons ▲ and ▼.
②	Press the AB button ▼ until the drive stops automatically. The upper end position has been set.
③	Press the AB button ▼ again until the Venetian blind has reached the desired lower end stop. The drive starts, stops briefly and then moves on (while the AB button ▼ is pushed). Correction is possible with the buttons ▲ and ▼.
④	Press the AUF button ▲ until the drive stops automatically. The lower end position has been set.
Setting of the end positions variant A is now complete.	

Fig. 8 End position setting Variant A:

17.6.7 Variant B: Fixed upper limit stop / lower end position freely adjustable

Variant B: Fixed upper limit stop / lower end position freely adjustable

- ① From a middle Venetian blind position with the assembly cable, push the **UP** button ▲ until the Venetian blind has reached the desired end position (run to the upper stop).
The drive starts, stops briefly and then moves on (while the UP button ▲ is pushed).
The drive switches off automatically when the upper limit stop is reached.
- ② Press the **AB** button ▼ until the drive stops automatically.
The upper end position has been set.
Optional: Activation of the relief function for the upper stop; see chapter 5.6.2
- ③ Press the **AB** button ▼ again until the Venetian blind has reached the desired lower end stop.
The drive starts, stops briefly and then moves on (while the button is pushed).
Correction is possible with the buttons ▲ and ▼.
- ④ Press the **AUF** button ▲ until the drive stops automatically.

Setting of the end positions variant B is now complete.

Fig. 9 End position setting Variant B:

17.6.8 Variant C: Fixed upper and lower limit stop

Variant C: Fixed upper and lower limit stop

- ① From a middle Venetian blind position with the assembly cable, push the **UP** button ▲ until the Venetian blind has reached the desired end position (run to the upper stop).
The drive starts, stops briefly and then moves on (while the UP button ▲ is pushed).
The drive switches off automatically when the upper limit stop is reached.
- ② Press the **AB** button ▼ until the drive stops automatically.
The upper end position has been set.
Optional: Activation of the relief function for the upper stop; see chapter 5.6.2
- ③ Press the **AB** button ▼ again until the Venetian blind has reached the lower end stop (run to lower end stop).
The drive starts, stops briefly and then moves on (while the DOWN button ▼ is pushed).
The drive switches off automatically when the lower limit stop is reached.
- ④ Press the **AUF** button ▲ until the drive stops automatically.
The lower end position has been set.
Optional: Activation of the relief function for the lower stop; see chapter 5.6.3

Setting of the end positions variant C is now complete.

Fig. 10 End position setting Variant C:

17.6.9 Variant D: Upper end position freely adjustable, fixed lower limit stop

Variant D: Upper end position freely adjustable, fixed lower limit stop

- ① From a middle Venetian blind position with the assembly cable, push the **UP** button ▲ until the Venetian blind has reached the desired end position.
The drive starts, stops briefly and then moves on (while the button is pushed).
Correction is possible with the buttons ▲ and ▼.
- ② Press the **DOWN** button ▼ until the drive stops automatically.
The upper end position has been set.
- ③ Press the **DOWN** button ▼ again until the Venetian blind has reached the lower end stop (run to lower end stop).
The drive starts, stops briefly and then moves on (while the DOWN button ▼ is pushed).
The drive switches off automatically when the lower limit stop is reached.
- ④ Press the **UP** button ▲ until the drive stops automatically.
The lower end position has been set.
Optional: Activation of the relief function for the lower stop; see chapter 5.6.3

Setting of the end positions variant D is now complete.

Fig. 11 End position setting Variant D:

18 Troubleshooting

Problem / Error	Possible cause	Cure Remedy
• Drive stops during travel	• End positions are not set • Drive is in setting mode	• Set end positions
• Drive stops after a short time	• End position programmed • Sluggish shutter	• Set second end position • Check smooth running of the Venetian blind
• Drive runs only in one direction	• Connection error	• Check connection
• Drive not responding	• No mains voltage • Temperature limiter has tripped	• Check mains voltage • Allow drive to cool
• Drive does not learn any end positions	• Random travel • Travel to end position or limit stop too short	• Delete end positions Reset end positions • Drive must run, stop briefly and run on (while a button is pushed at the assembly cable).

Fig. 12 Error search at the RolTop

19 Repair

The RolTop is maintenance free.

20 Repair

Please contact your dealer if you have any questions. Please always provide the following information:

- Item number and name on the type plate
- Type of fault
- Previous and unusual events
- Surrounding circumstances
- Own assumption

21 Manufacturer's address

elero GmbH Antriebstechnik Maybachstr. 30 73278 Schlerbach Deutschland / Germany	Phone: +49 7021 9539-0 Fax: +49 7021 9539-212 info@elero.de www.elero.com
---	--

Please visit our website if you require a contact outside Germany.

22 Disassembly and disposal

Dispose of the packaging according to current regulations.

Dispose the product after previous use in accordance with applicable regulations.

Environmental information

No unnecessary packaging was used. The packaging can be easily divided into three material types: Cardboard (box), Styrofoam (padding) and polyethylene (bag, foam material protective foil).

The device is made up of materials that can be reused if it is disassembled by a specialist operation. Please observe the local provisions on disposal of packaging material and old devices.

Always expect additional danger that does not occur in operation during disassembly.

WARNING

Danger of injury due to electric current.

Electric shock possible.

- ▶ Physically disconnect power supply lines and discharge charged energy storage. Wait for at least 5 minutes after deactivation for the motor to cool down and the capacitors to lose their voltage.
- ▶ Use suitable, tested and stable climbing aids when performing disassembly work above body height.
- ▶ All work at the electrical system must only be performed by the staff described in the chapter "Safety instructions for electrical installation".

Scrapping

During the scrapping of the product, the international, national and regional-specific laws and regulations are to be complied with.



Please make sure to consider material recyclability, ease of dismantling, and separability of materials and components as well as environmental and health hazards during recycling and disposal.



CAUTION

Environmental damage at incorrect disposal

- ▶ Electronic scrap and electronic components are subject to the hazardous waste rules and must only be disposed of by approved specialist operation.
- ▶ Groups of materials such as plastics and metals of various kinds are sorted for recycling and disposal process.

Dispose electrical and electronic components

Disposal and recycling of electric and electronic components must comply with the applicable national laws and regulations.

23 Conformity Declaration



elero GmbH hereby declares that this product corresponds to the applicable directives. The complete declaration of conformity can be found under www.elero.com.

24 Technical data and dimensions

The indicated technical data are subject to tolerances (according to the respective applicable standards).

Technical data and dimensions

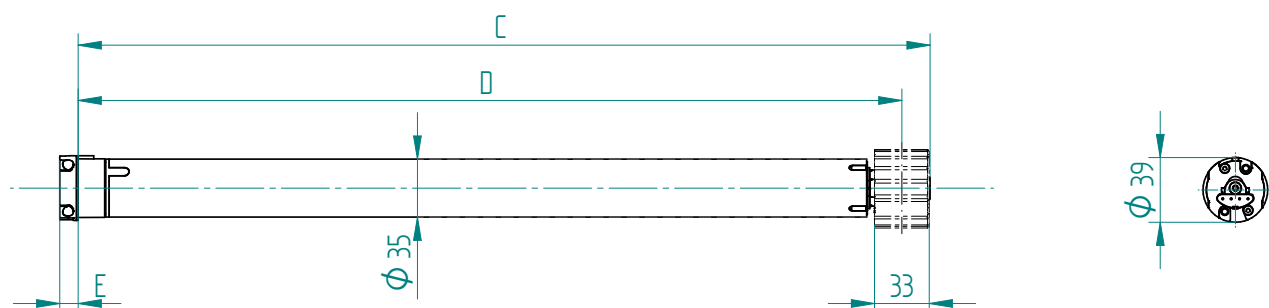

24.1 RevoLine S

Baugröße / Typ	S1,5/70	S3/30	S5/30	S5	S8	S10 FL	S12 FL	S12/11 FL
Roller shutter			■	■	■	■	■	■
Roller blind	■	■	■	■	■	■	■	■
Noiseless soft brake	■	■	■	■	■	-	-	-
Rated voltage [V]	1 ~ 230	1 ~ 230	1 ~ 230	1 ~ 230	1 ~ 230	1 ~ 230	1 ~ 230	1 ~ 230
Rated frequency [Hz]	50	50	50	50	50	50	50	50
Rated torque [Nm]	1,5	3	5	5	8	10	12	12
Rated speed [1/min]	70	30	30	17	17	17	17	11
Rated current [A]	0,55	0,55	0,73	0,55	0,73	0,55	0,73	0,55
Rated power consumption [W]	130	130	168	130	168	130	168	130
Shaft Ø [mm]	38	38	38	38	38	38	38	38
Limit switch range (turns)	160	80	80	40	40	40	40	40
Ingress protection (IP-Code)	44	44	44	44	44	44	44	44
Operation duration (min S2)	5	5	4	5	4	4	4	4
Length C [mm]	534	534	534	534	534	514	534	514
Length D [mm]	517	517	517	517	517	497	517	497
Length E [mm]	11	11	11	11	11	11	11	11
Weight [kg]	1,3	1,2	1,2	1,2	1,3	1,2	1,4	1,2
Temperature range [°C]	-20 ... 60	-20 ... 60	-20 ... 60	-20 ... 60	-20 ... 60	-20 ... 60	-20 ... 60	-20 ... 60
Protection class I 	■	■	■	■	■	■	■	■
Conformity  	■ ■	■ ■	■ ■	■ ■	■ ■	■ ■	■ ■	■ ■
Item number (round head / starhead)	302210001	302110001	302310001	302330001	302530001	308230001	308130001	30815001



Technical data and dimensions

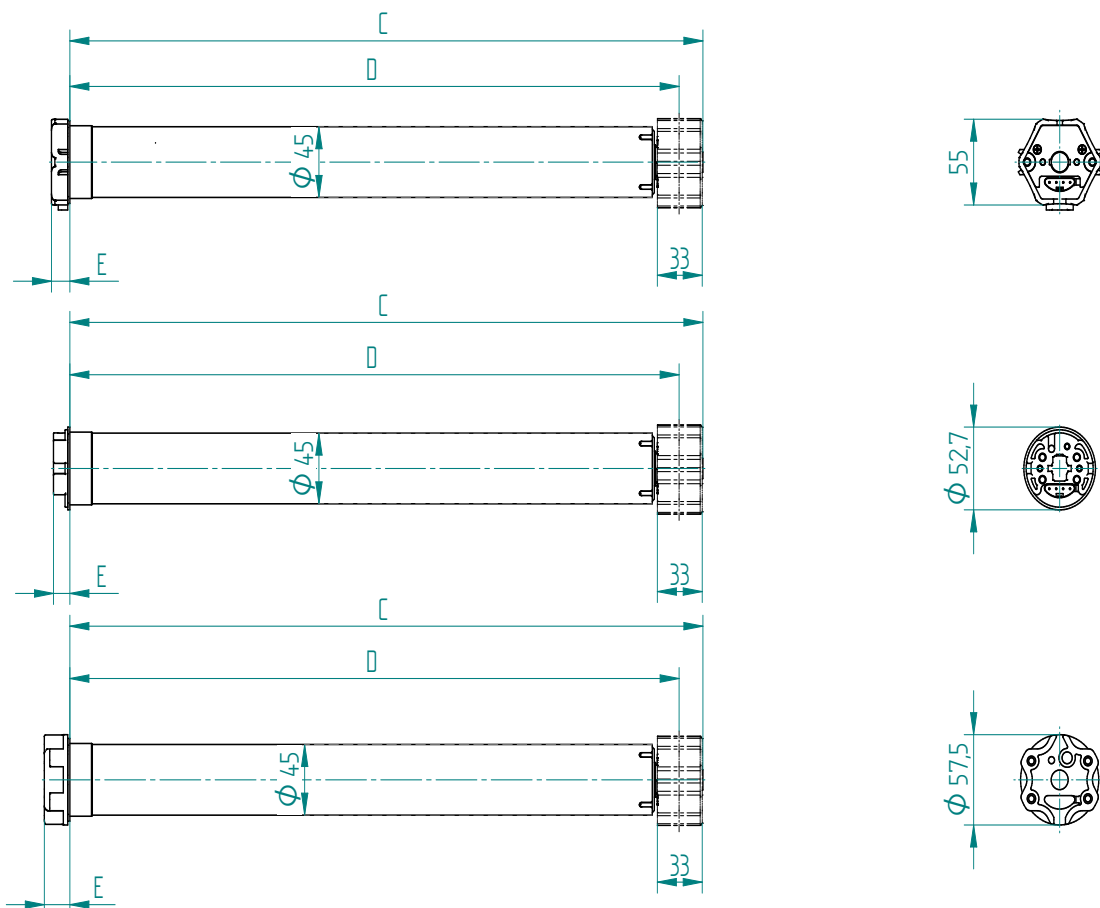

24.2 RevoLine M

Type	M6	M7/23	M10	M10-K	M12/23	M20	M30	M40	M50
Max. torque [Nm]	6	7	10	12	20	20	30	40	50
Speed [1/min]	14	23	14	14	23	14	14	14	14
Operating voltage [V]	1 ~ 230	230 ... 240	1 ~ 230	1 ~ 230	1 ~ 230	1 ~ 230	1 ~ 230	1 ~ 230	1 ~ 230
Frequency [Hz]	50	50	50	50	50	50	50	50	50
Noiseless soft brake	■	■	■	■	■	■	-	-	-
Current [A]	0,52	0,60	0,60	0,60	0,90	0,90	0,90	1,20	1,30
Power [W]	118	140	140	140	200	200	200	270	300
Shaft Ø [mm]	50	50	50	50	50	50	50	50	50
Ingress protection (IP-Code)	44	44	44	44	44	44	44	44	44
Llimit switch range (turns)	40	40	40	40	40	40	40	40	40
Operating mode (min S2)	5	5	5	4	4	4	4	5	4
Length C [mm]	446	466	466	391	526	526	516	546	546
Length D [mm]	429	449	449	374	509	509	499	529	529
Length E [mm] (elero, round head, starhead)	14 12 19	14 12 19	14 12 19	14 12 19	14 12 19	14 12 19	14 12 19	14 12 19	14 12 19
Weight [kg]	1,6	1,7	1,7	1,9	2,2	2,2	2,3	2,5	3,1
Temperature range [°C]	-20 ... 60	-20 ... 60	-20 ... 60	-20 ... 60	-20 ... 60	-20 ... 60	-20 ... 60	-20 ... 60	-20 ... 60
Protection class I 	■	■	■	■	■	■	■	■	■
Conformity  	■, ■	■, ■	■, ■	■, ■	■, ■	■, ■	■, ■	■, ■	■, ■
Item number (elero, round head, starhead)	343010001 393010001	342250001 382250001	342210001 382210001 392210001	341110001 381110001	342350001 382350001	342310001 382310001 392310001	342410001 382410001 392410001	342510001 392510001	342610001 392610001



Technical data and dimensions

24.3 RevoLine s_onro M

Baugröße/Typ	RoI top s_onro				
	M10	M20	M30	M40	M50
Rated voltage (V)	230 - 240	1 ~ 230	1 ~ 230	1 ~ 230	1 ~ 230
Rated frequency (Hz)	50	50	50	50	50
Noiseless soft brake	•	•	–	–	–
Rated torque (Nm)	10	20	30	40	50
Rated speed (1/min)	14	14	14	14	14
Rated current (A)	0,60	0,90	0,90	1,05	1,30
Rated power consumption (W)	140	200	200	242	300
Shaft diameter (mm)	50	50	50	50	50
Protection class (IP)	44	44	44	44	44
Limit switch range (turns)	40	40	40	40	40
Operation duration (min S2)	5	4	4	5	4
Length C (mm)	466	526	516	546	546
Length D (mm)	449	509	499	529	529
Length E (mm) elero head	14	14	14	14	14
Length E (mm) star head	19	19	19	19	19
Weight (kg)	1,9	2,2	2,3	2,5	3,1
Operation environment temperature (°C)	–20 bis +60	–20 bis +60	–20 bis +60	–20 bis +60	–20 bis +60
Conformity  	• •	• •	• •	• •	• •
Emission sound pressure level (dBA)	< 70	< 70	< 70	< 70	< 70
Protection class I	•	•	•	•	•
Plug-in connecting (m)	2,0	2,0	2,0	2,0	2,0

Item number elero head	34 221.5601	34 231.5601			
Item number star head	39 221.5601	39 231.5601	39 241.5601	39 251.5601	39 261.5601

Technical data and dimensions

24.4 RevoLine L

Build / Type	RoTop	
	L60	L80
Rated voltage (V)	1 ~ 230	
Rated frequency (Hz)	50	
Noiseless soft brake	-	
Application protection up and down and reversion on obstacle	•	
Rated torque (Nm)	60	80
Rated speed (1/min)	14	
Rated current (A)	1,9	2,0
Rated power consumption (W)	430	470
Shaft diameter (mm)	63	
Protection class (IP)	44	
Limit switch range (turns)	40	
Operating duration (min S2)	4	
Length C (mm)	575	
Length D (mm)	558	
Length E (mm)	14	
Weight (kg)	3,3	3,6
Operating environment temperature (°C)	-20 bis +60	
Emission sound pressure level (dBA)	< 70	
Protection class I	•	
Plug-in connecting cable (m)	2,0	

Item number	36 731.0001	36 741.0001
-------------	-------------	-------------

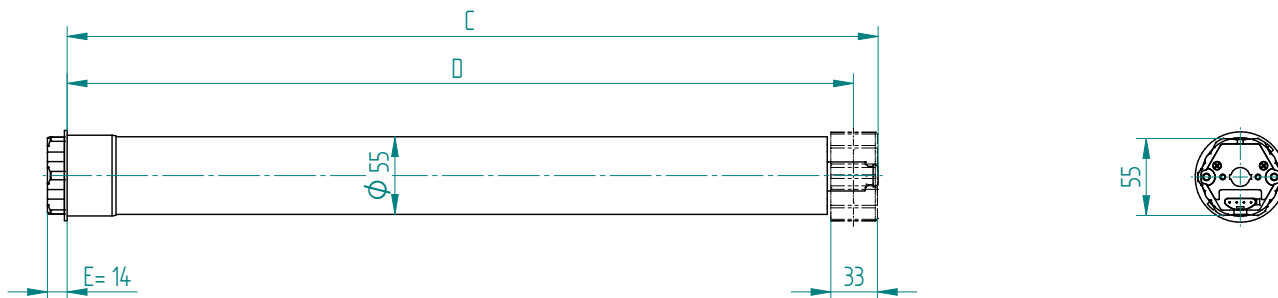

Technical data and dimensions
