

Table Of Contents

1	Operating and installation instructions	1
2	General for instructions	1
2.1	Standards and Directives	1
2.2	Intended use	1
2.3	Foreseeable misuse	2
2.4	Warranty and liability	2
2.5	Customer service of the manufacturer	2
3	Safety	2
3.1	General safety instructions	2
3.2	Layout of the safety guidelines	2
4	Product description	3
5	Assembly	3
5.1	Mechanical fastening	4
5.2	Electrical connection	4
5.3	Connection example, RolTop /D+ 868 230 V/50 Hz	4
5.4	Initial operation	5
5.4.1	Connection for cable assembly	5
5.4.2	Connection for radio (transmission operation)	5
5.4.3	Changing / Deleting the end positions	5
5.4.4	Programme or delete further curtain positions	5
5.5	Programming the transmitter	5
5.6	Programming (additional) transmitter	5
6	Troubleshooting	6
7	Maintenance	6
8	Repair	6
9	Manufacturer's address	6
10	Disassembly and disposal	6
11	Notes on the EC declaration of conformity	7
12	Technical data and dimensions	7

Roller shutter drive RolTop /D+ 868

1 Operating and installation instructions

Please keep these operating instructions for later use, to be available throughout the life of the product!

The German manual is the original version.

All other documents represent the language translations of the original text.

All rights in the case of a patent, utility model or ornamental design registration are reserved.

2 General for instructions

The content structure is based on the life cycles of the electric motor drive (hereinafter referred to as "Product").

The manufacturer reserves the right to make changes to the Specifications stated in these Operating Instructions at any time. These may, in individual cases, be different from the respective product version, however the functional information will not undergo significant changes or become invalid. The current version of the Specifications may be requested from the manufacturer at any time. No claims may be asserted against the manufacturer as a result of the preceding sentence. Deviations from text or picture statements are possible and depend on the technical development, features, and accessories of the products. Deviating information on special versions will be explained by the manufacturer in the sales documentation. Other information shall remain unaffected by these provisions.

2.1 Standards and Directives

During the design process, the basic health and safety requirements of the applicable laws, Standards and Directives were complied with. The safety is confirmed by the declaration of conformity (see "Declaration of Conformity"). All safety information in these Operating Instructions refer to the laws and regulations currently applicable in Germany. All instructions in the Operating Instructions shall be observed without limitation and at any time. Beside the safety instructions contained in these Operating Instructions, the provisions for accident prevention, environmental protection and occupational safety, which are applicable for the operating site, must be observed. Provisions and Standards for the safety rating can be found in the EC Declaration of Conformity

2.2 Intended use

The product is intended for use in façade engineering to drive electrically powered roller shutters.

The determining factor for the drive is the elero drive computation program (<http://elero.com/de/service/antriebsberechnungsprogramm.htm>).

Further fields of application have to be arranged with the manufacturer, **elero** GmbH Antriebstechnik (see Address).

The operator will be solely responsible for damages resulting from improper use of the product. The manufacturer cannot be held liable for personal or material damages caused by misuse or procedural errors, and by improper operation and commissioning.

The product may be operated only by trained and authorized personnel under observance of all safety.

Only if used according to the specifications of these operating and installation instructions for the safe and proper use and safe operation of the product are guaranteed.

Only use radio receivers with equipment and units approved by the manufacturer. The operator does not benefit from any protection whatsoever against interference from other remote control equipment and terminal equipment (e.g. also from radio equipment which is correctly operated in the same frequency range). Please note that radio systems must not be operated in areas with an increased risk of interference (e.g. hospitals, airports,....). The radio control is only permitted for devices and units with which a functional interference in hand-held/wall transmitters or receivers poses no danger for persons, animals or materials or where this risk is covered by other safety appliances.

Intended use includes the observance and compliance with all safety instructions with regards to this operating manual and all applicable regulations, and professional associations of applicable laws for environmental protection. Intended use includes the observance of prescribed operating rules in these operating and installation instructions.

2.3 Foreseeable misuse

A use which deviates from the intended use stated by the manufacturer, **elero GmbH Antriebstechnik** (see "Address"), is deemed as foreseeable misuse.

2.4 Warranty and liability

Principally, the General Terms and Conditions of the manufacturer, **elero GmbH Antriebstechnik** (see "Address"), apply. The terms and conditions are part of the sales documents and handed over to the operator upon delivery. Liability claims for personal or material damages are excluded when they can be attributed to one or more of the following causes:

- Opening of the product by the customer
- Unintended use of the product
- Improper installation, commissioning, or operation of the product
- Structural modifications to the product without the written consent of the manufacturer
- Operation of the product with improperly installed connections, defective safety devices or improperly installed safeguards
- Non-observance of the safety provisions and instructions of these Operating Instructions
- Non-compliance with the technical data

2.5 Customer service of the manufacturer

The product should only be repaired by the manufacturer in case of a failure. The address for sending to customer service, see the chapter "Address". If you have not purchased the product directly from elero, please contact the supplier of the product.

3 Safety

3.1 General safety instructions

The instructions on safety that must be observed under all circumstances are included in the separately enclosed leaflet on safety instructions (13 820 0001).

3.2 Layout of the safety guidelines

The safety instructions in this document are identified by hazard signs and safety symbols and are designed according to the SAFE principle. They contain information on the nature and source of the danger of possible consequences and to prevent the danger.

The following table defines the representation and description of hazard levels with possible personal injury, as used in this manual.



Symbol	Signal word	Meaning
	DANGER	Warns before an accident, which will result if instructions are not followed, which can lead to life-threatening, irreversible injury or death.
	WARNING	Warns before an accident, which can happen if the instructions are not followed, which can lead to serious, possibly fatal, irreversible injury or death.
	CAUTION	Warns before an accident, which can happen if the instructions are not followed, which may lead to minor reversible injury.

Fig. 1 Notation of personal injury

The following table describes the icons used in these operating instructions that are used for imaging of the dangerous situation in connection with the symbol of the threat level.



Symbol	Meaning
	Danger of electric voltage, electric shock: This symbol indicates a risk of electric shock.

Fig. 2 Notation-specific hazard

The following table defines the representation used in the operating instructions and description of situations where damage can occur to the product or refers to important facts, conditions, tips and information.

Symbol	Signal word	Meaning
	NOTICE	This symbol warns of a possible property damage.

Symbol	Signal word	Meaning
	Important:	This symbol points out important facts and conditions as well as to additional information in these operating and installation instructions. It also refers to certain statements that give additional information or help you perform a task easily.

Fig. 3 Notation of property damage as well as additional information

The following example represents the basic structure of a safety warning:

SIGNAL WORD

Type and source of danger

Explanation of the type and source of the danger

- ▶ Measures to prevent the danger.

4 Product description

The RoITop /D + 868 is a radio-controlled electromechanical tubular motor drive. It performs parallel axial movements.

- ❑ Commissioning of the RoITop /D + 868 does not require any **elero** assembly cable. The elero assembly cable serves only for the deletion of the end positions and/or for restoring the delivery status if necessary. Commissioning of the RoITop /D+ 868 for setting of different functions takes place using the **elero** assembly cable or an **elero** radio transmitter.
- ❑ The RoITop /D + 868 needs fixed stops at the top and bottom. The use of rigid shaft connectors and plugs stop or angle strips or covert attacks is a prerequisite. There is a relief function at both stop points.
- ❑ If an obstacle is recognised, type S will perform a relief by approx. 2 motor turns; type M will perform approx. 1 motor turn (hanging protection with running free).
- ❑ When the same force deactivation has taken place three times in sequence at the top and bottom, the end positions have been set (self-learning).
- ❑ After obstacle recognition in the area of the end positions, they are immediately corrected down by up to 1 motor turn (360°) if, e.g., a window sill has been installed subsequently.

5 Assembly

CAUTION

Personal injury from hot surfaces.

Drive heats up during operation, the drive housing can be hot. Possible burning of the skin.

- ▶ Wear personal protective equipment (gloves).

Triggered by a possible material errors may occur or impact shock and injury due to a gearbox break, bud break or a clutch defect.

- ▶ Suitable materials are to be used for the construction as well as perform a sampling inspection by double load test according to DIN EN 60335-2-97.

Risk of injury due to impact or shock caused by not properly mounted or latched motor bearings. Hazards caused by insufficient stability or stability and stored energy (gravity).

- ▶ Selection of engine bearing torque specifications.
- ▶ Drive must be backed up with all attached backup devices.
- ▶ Check for proper latching on engine mounts and correct tightening torques.

WARNING

Danger of injury due to electric current.



Electric shock possible.

- ▶ Electrical work can only be performed by an authorized electrician.

Danger of injury due to electric current.



Hazardous possibly by parts that have become live in the error state.

- ▶ Electrical connection is described in the operating and installation instructions including cable bushing.

CAUTION

Risk of injury due to malfunctions due to improper installation.

Driven by winds and possibly destroyed parts of the application.

- ▶ For safe operation, the end positions must be set / programmed.
- ▶ Training program of the manufacturer for specialist companies.

NOTE



Loss of power supply, termination of machine parts and other malfunctions.

- ▶ For safe operation, no false mount must be made and the end position settings must be carried out during commissioning.



Damage to the RoITop /D + 868 due to moisture penetration

- ▶ For devices with protection class IP44, the ends of all cables or connectors must be protected against the ingress of moisture. This measure must be implemented immediately after removal of the RoITop /D+ 868 from the original packaging.
- ▶ The drive must be installed in a position in which it is not sprinkled.

Important



In the delivery status (factory setting), the RoITop /D + 868 in commissioning mode.

- ▶ You have to set the end positions (see chapter 5.6). This is done self-learning (torque-dependent).

Best utilisation of the radio signal.

- ▶ Place the aerial as freely as possible; in case of bad reception, move the aerial.
- ▶ Do not kink, shorten or extend the aerial.
- ▶ Do not undercut the minimum distance of 15 cm between two radio drives.

5.1 Mechanical fastening

Important preliminary consideration:

The working space around the built-in drive is usually very small. Therefore, before the mechanical installation provide an overview of the implementation of the electrical connection (see Section 5.2) and make any necessary changes right away.

NOTICE



Damage to the electrical wiring by squeezing or tensile loading.

- ▶ Route all electrical cables so that they are not subjected to crushing or tensile load.
- ▶ Note the bending radius of the cables (at least 50 mm).
- ▶ Lay the connection cable in a loop downwards to prevent water running into the drive.



Damage to the drive by the action of impact forces.

- ▶ Insert the drive into the shaft, never thrust the drive into the shaft or smash onto the drive!
- ▶ Never allow the drive to fall!



Damage or destruction of the drive by drilling.

- ▶ Never drill into the drive!

Important



Attach the RolTop /D + 868 only at the intended fasteners.

Permanently installed control devices shall be clearly displayed.

- The curtain must be fastened to the winding shaft.
- The profile tube must have enough distance to the motor tube.
- Look for an axial clearance (1-2 mm).

Installation in profile tubes

Ⓐ Insert the drive with a suitable adapter and traction ring into the profile tube.

Lay the motor cable protected in order to prevent damage by the driven component.

Ⓑ Secure the counter bearings against axial displacement, e.g. screw shaft spider or rivet.

Secure drive in axial storage!

Ⓒ Secure hanging on the shaft!

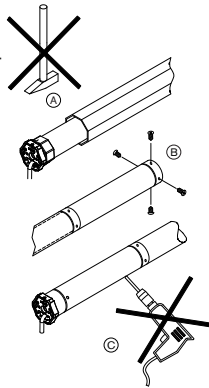

5.2 Electrical connection

WARNING

Danger to life due to faulty electrical connection.



Electric shock possible.

- ▶ Before commissioning check the correct connection of the PE conductor.

NOTICE



Damage to the RolTop /D + 868 by faulty electrical connection

- ▶ Before commissioning check the correct connection of the PE conductor.



Damage or destruction of RolTop /D + 868 by the penetration of moisture

- ▶ For units with protection class IP 44, the customer connection of the cable ends or connector (cable bushing) must also be carried out in accordance with protection class IP 44.



Damage to the Venetian blind from incorrect running direction

- ▶ The assignment of the running direction UP/DOWN with an elero radio transmitter must be reviewed after teaching.



Adjustment of the end position at the drive.

- ▶ Any adjustment of the end positions that occurs indicates an electrical connection error. Readjustment of the end positions is not sufficient in this case, since the end positions are adjusted often. In this case, the drive needs to be replaced and the cause removed.

Important

All applicable standards and provisions must be observed for the electrical installation.

When connecting the drive to a control, the operating instructions of the control must be observed.

For electric connection no transmission and retransmission of the access line or connector is required as a rule.

Depending on the mounting plate and/or adapter plate used it is necessary in particular with the RolTop /D+ 868 to remove this screwed plate before a cable exchange.

Connection only in free of tension status, in addition drive line without tension

- 1 Using a suitable screwdriver, press out the lock of the device connector to the line.
- 2 Disconnect the plug.
- 3 Insert connector until the latch engages.

Removal and insertion of the device plug		
Delivery status	Remove plug	Insert plug

Fig. 4 Removal and insertion of the device plug

5.3 Connection example, RolTop /D+ 868 230 V/50 Hz

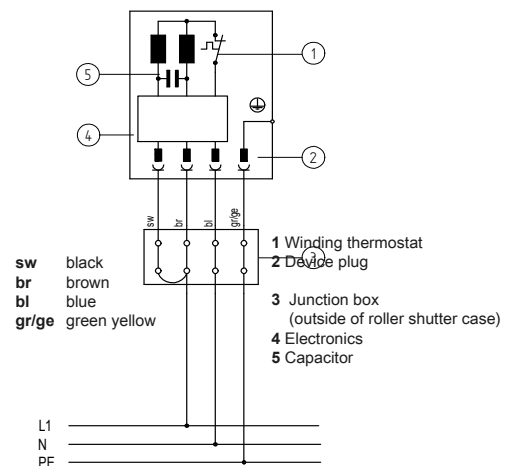

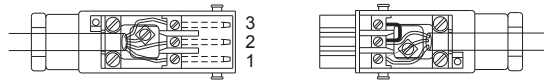

Fig. 5 Circuit diagram RolTop /D+ 868 230 V / 50 Hz and wiring at use with Hirschmann plug STAS 3 (with jumper)

5.4 Initial operation

5.4.1 Connection for cable assembly

As an alternative to the fixed connection, the **elero** assembly cable can also be used for setting. However, this is not necessary.

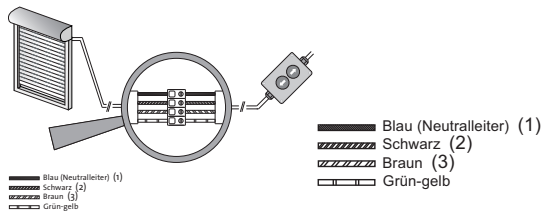

Fig. 6 Connection for cable assembly

5.4.2 Connection for radio (transmission operation)

Commissioning with an **elero** wall/hand transmitter (teaching in of an **elero** transmitter to the radio drive RolTop /D+ 868) takes place according to the respective description ("Teach in transmitter") of the **elero** transmitter. Also see chapter 5.5 "Teach in transmitter".

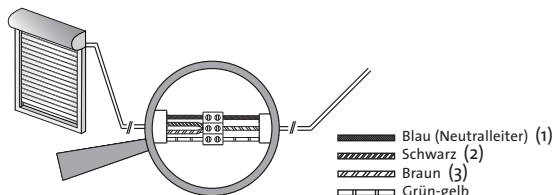

Fig. 7 Connection for radio (transmission operation)

Important

After successful drive assembly the drive must be driven 3 times altogether into the lower end position and 3 times into the upper end position. The drive must stop automatically.

The sunblind is adjusted only after a complete and uninterrupted access and exit to the blind.

5.4.3 Changing / Deleting the end positions

A change or deletion of a single end position is not possible. This always happens in pairs (upper and lower end position at the same time).

After a short separation from the supply network, the drive will be ready for deletion for approx. 5 seconds.

Changing / Deleting the end positions	
1	Restore voltage supply after mains interruption.
2	From a middle Venetian blind position with the assembly cable or a taught-in transmitter, push and hold both direction buttons (▲ and ▼) at the same time until the drive moves up and down briefly.
The deletion of the setting of end position is completed. The end positions can be programmed again.	

5.4.4 Programme or delete further curtain positions

Programme or delete interim positions: See **elero** transmitter instructions.

Programme or delete interim positions: See **elero** transmitter instructions.

5.5 Programming the transmitter

Important



Condition: The drive is in radio mode.

► If the end positions have not been taught-in, remove the blind from the coiling shaft.

Programming (first) transmitter		
	Instructions for action	Result
1	Switch the mains off and on again.	The drive is then ready to teach-in for about 5 minutes.
2	Push the teaching button P on the transmitter to be taught in for about 1 second.	The status indicator is lit. The drive is now ready to teach-in (running up/down) (for about 2 minutes).
3	Press the UP button ▲ as soon as the blind starts moving in upwards direction (within 1 second at the most).	The status indicator is lit briefly. The blind stops moving again and then moves downwards.
4	Press the DOWN button ▼ as soon as the blind starts moving in downwards direction (within 1 second at the most).	The status indicator is lit briefly. The drive will stop.
The (first) transmitter has been through the teach-in procedure.		

5.6 Programming (additional) transmitter

Programming possible for max. 16 transmitters

Programming (additional) transmitter		
	Instructions for action	Result
1	On an <i>already taught-in transmitter</i> , push the buttons UP ▲ , DOWN ▼ and the teaching button P at the same time for approx. 3 seconds.	The drive is then ready to teach-in for about 5 minutes.
	<i>(alternative to the above line)</i> Switch the mains off and on again.	<i>The drive is then ready to teach-in for about 5 minutes.</i>
2	Push the teaching button P on the transmitter to be taught in (additionally).	The status indicator is lit briefly. The drive is in teach-in mode (running up/down) (for about 2 minutes).

Programming (additional) transmitter		
	Instructions for action	Result
4	Press the UP button ▲ on the transmitter to be taught in (additionally) as soon as the blind starts moving in upwards direction (within 1 second at the most).	The status indicator is lit briefly. The blind stops briefly, starts moving again and then moves downwards.
5	Press the DOWN button ▼ on the transmitter to be taught in (additionally) as soon as the blind starts moving in downwards direction (within 1 second at the most).	The status indicator is lit briefly. The drive will stop.
The additional transmitter has been through the teach-in procedure.		

Stop bidirectional radio teaching mode:
Keep the **STOP** button pushed for at least 6 seconds until the status display lights up (depending on transmitter).

6 Troubleshooting

Problem / Error	Possible cause	Cure
		Remedy
• Drive stops after a short time	• Sluggish shutter	• Check smooth running of the Venetian blind
• Drive runs only in one direction	• Connection error	• Check connection
• Drive not responding	• No mains voltage • Temperature limiter has tripped	• Check mains voltage • Allow drive to cool
• Drive does not learn any end positions	• Stop missing or no mechanical limit present	• Delete end positions • Install mechanical stops

Fig. 8 Troubleshooting for the RolTop /D+ 868

7 Maintenance

The RolTop /D + 868 is maintenance-free.

8 Repair

Please contact your dealer if you have any questions. Please always provide the following information:

- Item number and name on the type plate
- Type of fault
- Previous and unusual events
- Surrounding circumstances
- Own assumption

9 Manufacturer's address

elero GmbH Antriebstechnik Linsenhofer Str. 65 72660 Beuren Deutschland / Germany	Phone: +49 7025 13-01 Fax: +49 7025 13-212 info@elero.de www.elero.com
--	---

Please visit our website if you require a contact outside Germany.

10 Disassembly and disposal

Dispose of the packaging according to current regulations.

Dispose the product after previous use in accordance with applicable regulations. Disposal is partially subject to statutory provisions. The goods to be disposed of must only be delivered to authorised acceptance points.

Environmental information

No unnecessary packaging was used. The packaging can be easily divided into three material types: Cardboard (box), Styrofoam (padding) and polyethylene (bag, foam material protective foil).

The device is made up of materials that can be reused if it is disassembled by a specialist operation. Please observe the local provisions on disposal of packaging material and old devices.

Always expect additional danger that does not occur in operation during disassembly.



WARNING

Danger of injury due to electric current.

Electric shock possible.

- ▶ Physically disconnect power supply lines and discharge charged energy storage. Wait for at least 5 minutes after deactivation for the motor to cool down and the capacitors to lose their voltage.
- ▶ Use suitable, tested and stable climbing aids when performing disassembly work above body height.
- ▶ All work at the electrical system must only be performed by the staff described in the chapter "Safety instructions for electrical installation".

Scrapping

During the scrapping of the product, the international, national and regional-specific laws and regulations are to be complied with.



Please make sure to consider material recyclability, ease of dismantling, and separability of materials and components as well as environmental and health hazards during recycling and disposal.



CAUTION

Environmental damage at incorrect disposal

- ▶ Electronic scrap and electronic components are subject to the hazardous waste rules and must only be disposed of by approved specialist operation.
- ▶ Groups of materials such as plastics and metals of various kinds are sorted for recycling and disposal process.

Dispose electrical and electronic components



Disposal and recycling of electric and electronic components must comply with the applicable national laws and regulations.

Technical data

11 Notes on the EC declaration of conformity

elero GmbH hereby declares that the pipe drive RolTop /D+ 868 complies with the basic prerequisites and the other relevant provisions of the EC directives. The complete declaration of conformity can be found in the download area of our website.

12 Technical data and dimensions

Dimensions/ Type	RolTop D+ S5-868	RolTop D+ S8-868	RolTop D+ S12-868	RolTop D+ M10-868	RolTop D+ M20-868	RolTop D+ M30-868
Noiseless soft brake	•	•	•	•	•	–
Rated torque Nm	5	8	12	10	20	30
Rated speed [rpm]	17	17	17	14	14	14
Rated current [A]	0.55		0.73	0.60	0.90	
Rated power consumption [W]	130		168	140	200	
Shaft diameter [mm]	38			50		
Limit switch range [turns]	40					
Operating duration [min S2]	5	4	4	5	5	4
Length A [mm]	545	545	545	480	540	530
Length B [mm]	515.5	515.5	515.5	462	523	512
Weight [kg]	1.2	1.3	1.3	1.9	2.2	2.3
Protection class [IP-code]	IP44					
Emitted sound level (A-assessed)	< 70 dB(A)					
Operating environment temperature [°C]	-20 to 60					
Electromagnetic compatibility						
VDE mark						
CE mark	